

Used At:	Author:	Date: 11/01/2012	WORKING	READER	DATE	CONTEXT:
	Project: Model Processos CRAI Rev: 17/05/2017		DRAFT			
	Notes: 1 2 3 4 5 6 7 8 9 10		RECOMMENDED			
			PUBLICATION			

Purpose: Interrelacionar els processos existents

Viewpoint: Equip Guia

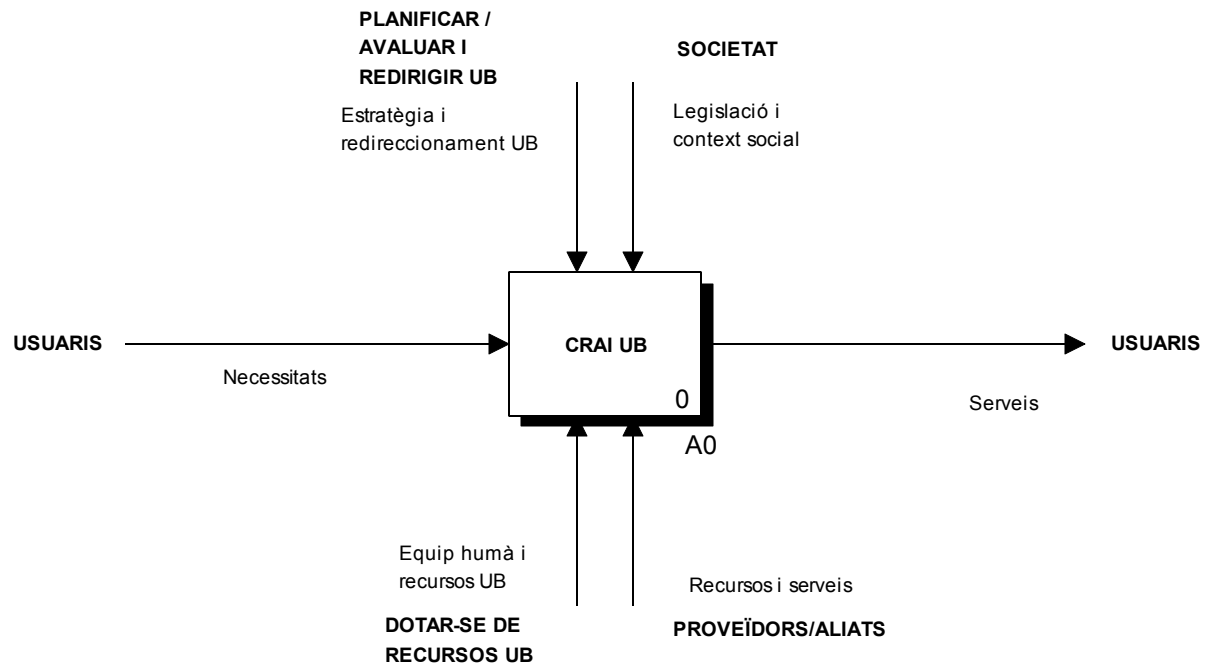

Node: A-0	Title: Model Processos CRAI	Number:	Page: 1
--------------	--------------------------------	---------	---------

Used At:	Author:	Date: 11/01/2012	WORKING	READER	DATE	CONTEXT: ■ A-0
	Project: Model Processos CRAI Rev: 11/01/2012		DRAFT			
	Notes: 1 2 3 4 5 6 7 8 9 10		RECOMMENDED			
			PUBLICATION			

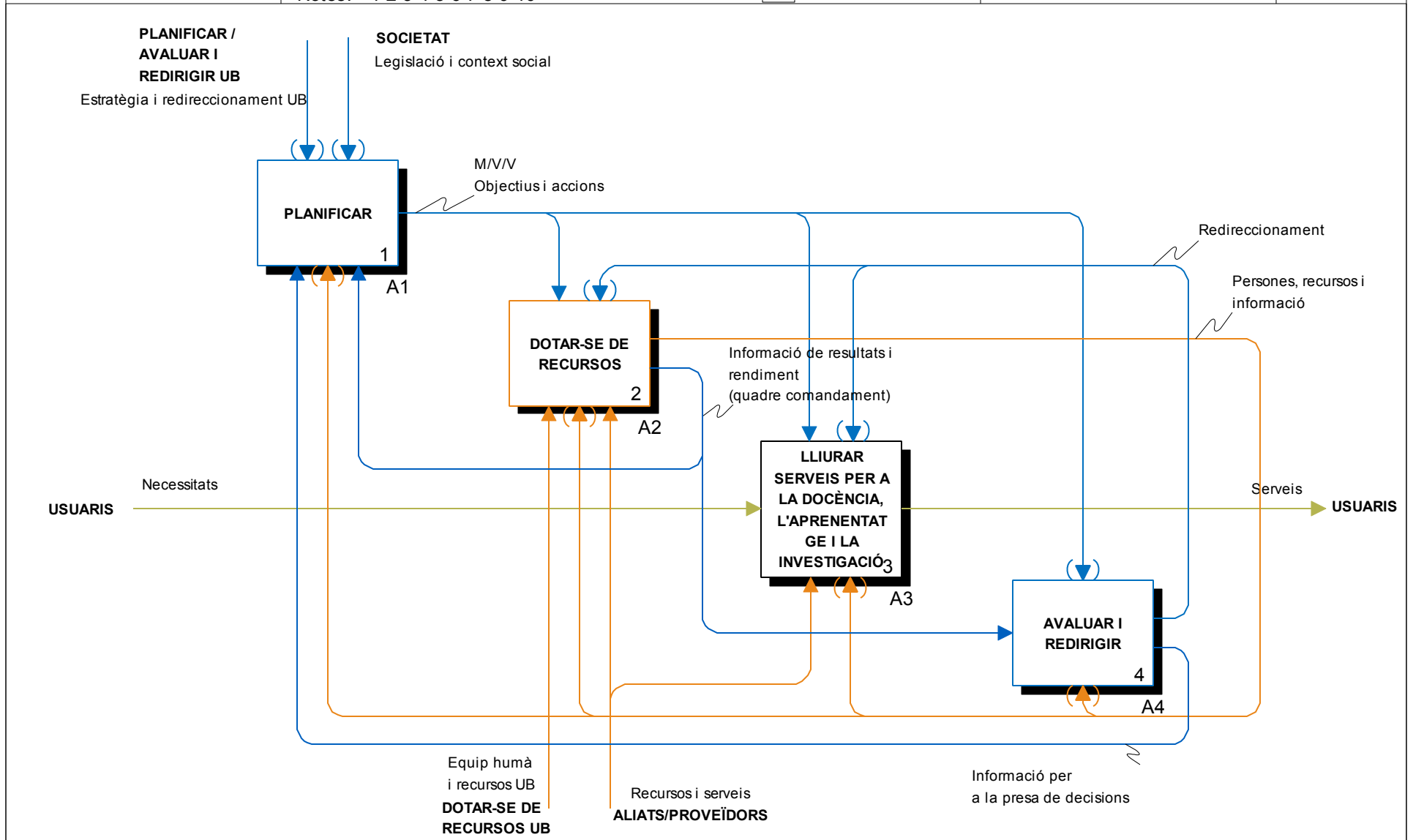

Node: A0	Title: CRAI UB	Number:	Page: 2
----------	----------------	---------	---------

Used At:	Author:	Date: 11/01/2012	WORKING	READER	DATE	CONTEXT: <input type="checkbox"/> <input type="checkbox"/> <input checked="" type="checkbox"/> <input type="checkbox"/> A0
	Project: Model Processos CRAI Rev: 11/01/2012		DRAFT			
	Notes: 1 2 3 4 5 6 7 8 9 10		RECOMMENDED			
			PUBLICATION			

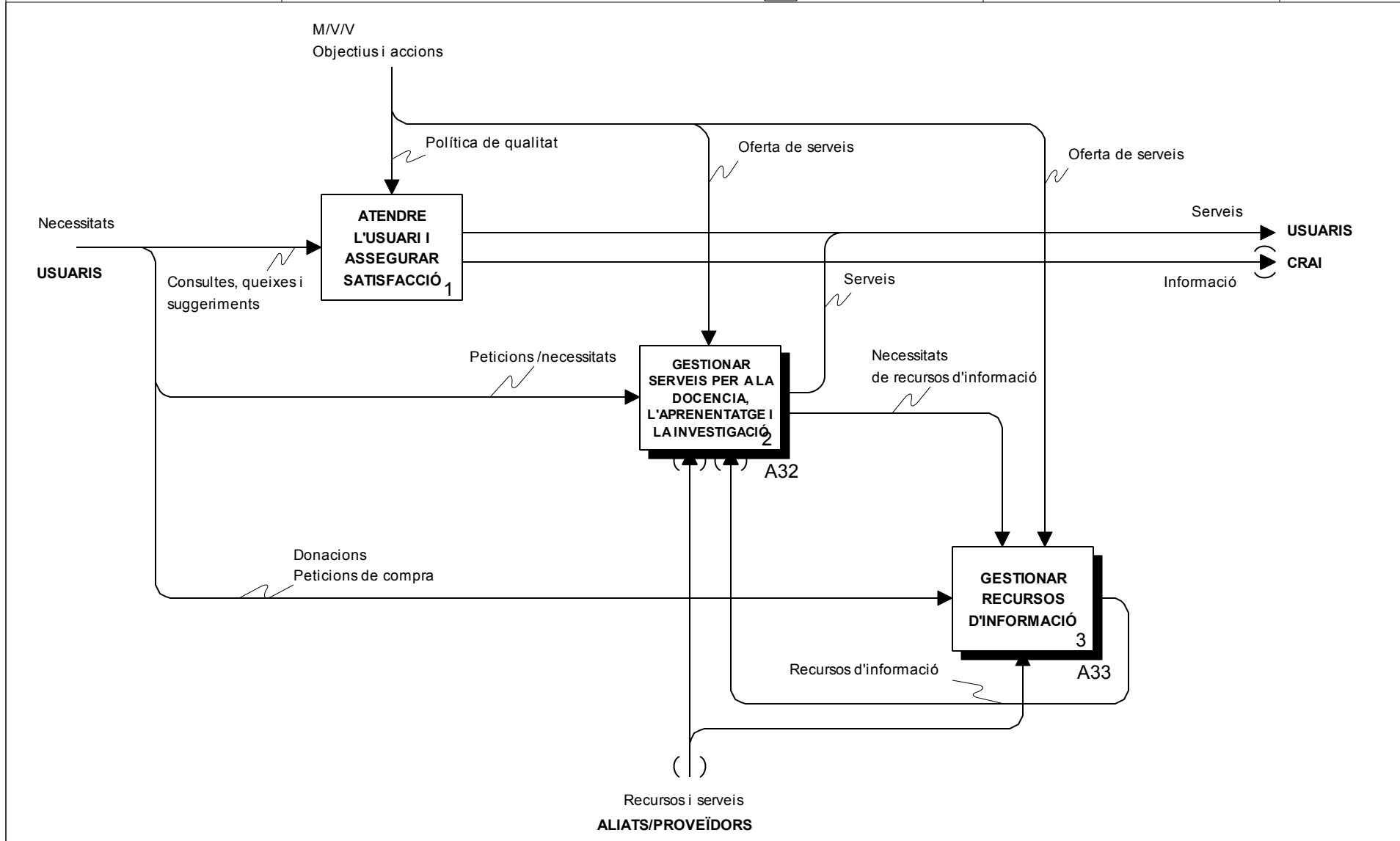

Node: A3	Title: LLIURAR SERVEIS PER A LA DOCÈNCIA, L'APRENTATGE I LA INVESTIGACIÓ	Number:	Page: 13
-------------	---	---------	----------

Used At:	Author:	Date: 11/01/2012	WORKING	READER	DATE	CONTEXT: <input type="checkbox"/> <input type="checkbox"/> <input checked="" type="checkbox"/> A3
	Project: Model Processos CRAI Rev: 11/01/2012		DRAFT			
	Notes: 1 2 3 4 5 6 7 8 9 10		RECOMMENDED			
			PUBLICATION			

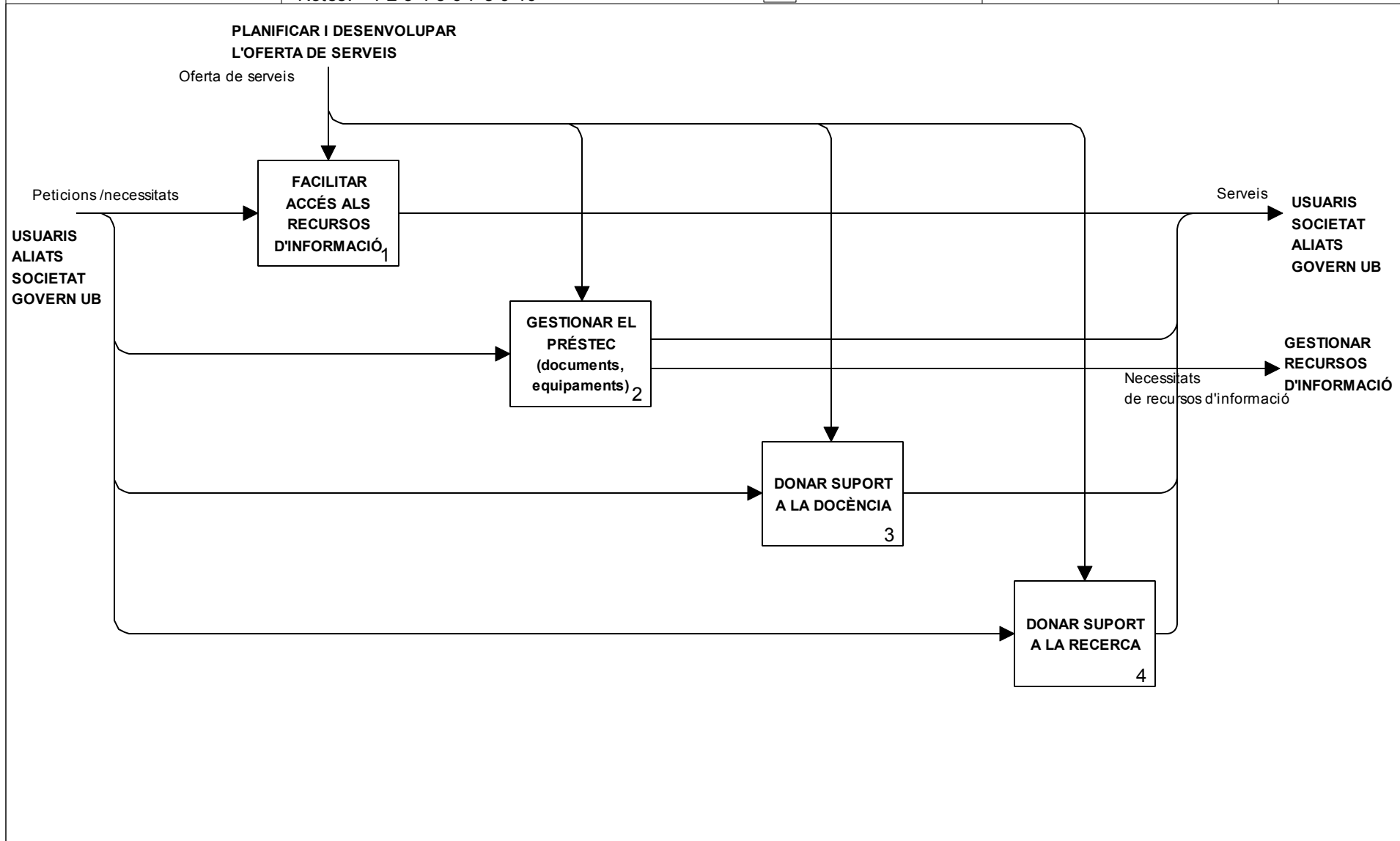

Used At:	Author:	Date: 16/01/2012	WORKING	READER	DATE	CONTEXT: <input checked="" type="checkbox"/> <input type="checkbox"/> <input type="checkbox"/> <input type="checkbox"/> A0
	Project: Model Processos CRAI Rev: 16/01/2012		DRAFT			
	Notes: 1 2 3 4 5 6 7 8 9 10		RECOMMENDED			
			PUBLICATION			

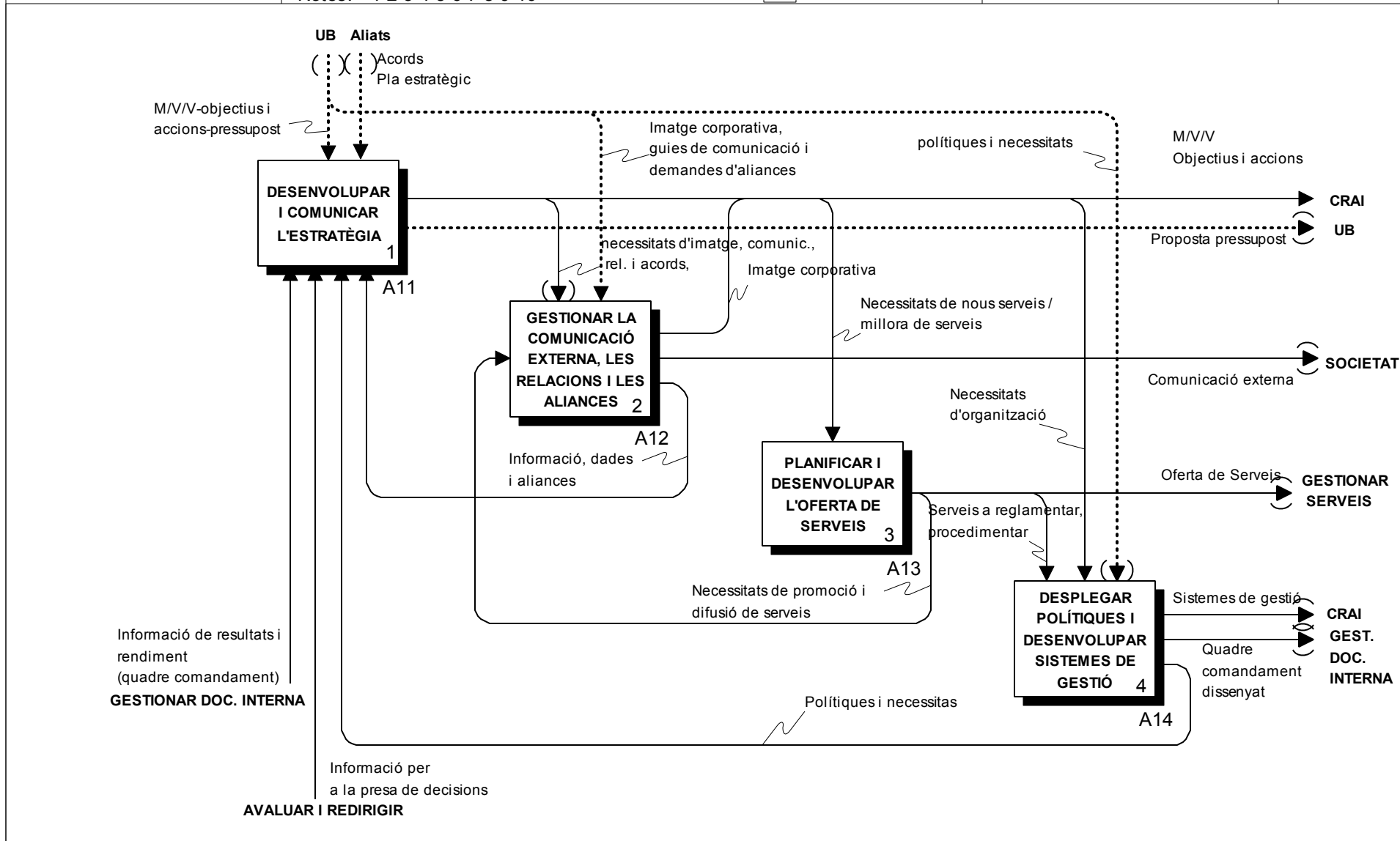

Node: A1	Title: PLANIFICAR	Number:	Page: 3
----------	-------------------	---------	---------

Used At:	Author:	Date: 16/01/2012	WORKING	READER	DATE	CONTEXT:
	Project: Model Processos CRAI Rev: 16/01/2012		DRAFT			<input type="checkbox"/>
	Notes: 1 2 3 4 5 6 7 8 9 10		RECOMMENDED			<input checked="" type="checkbox"/>
			PUBLICATION			<input type="checkbox"/>
						A0

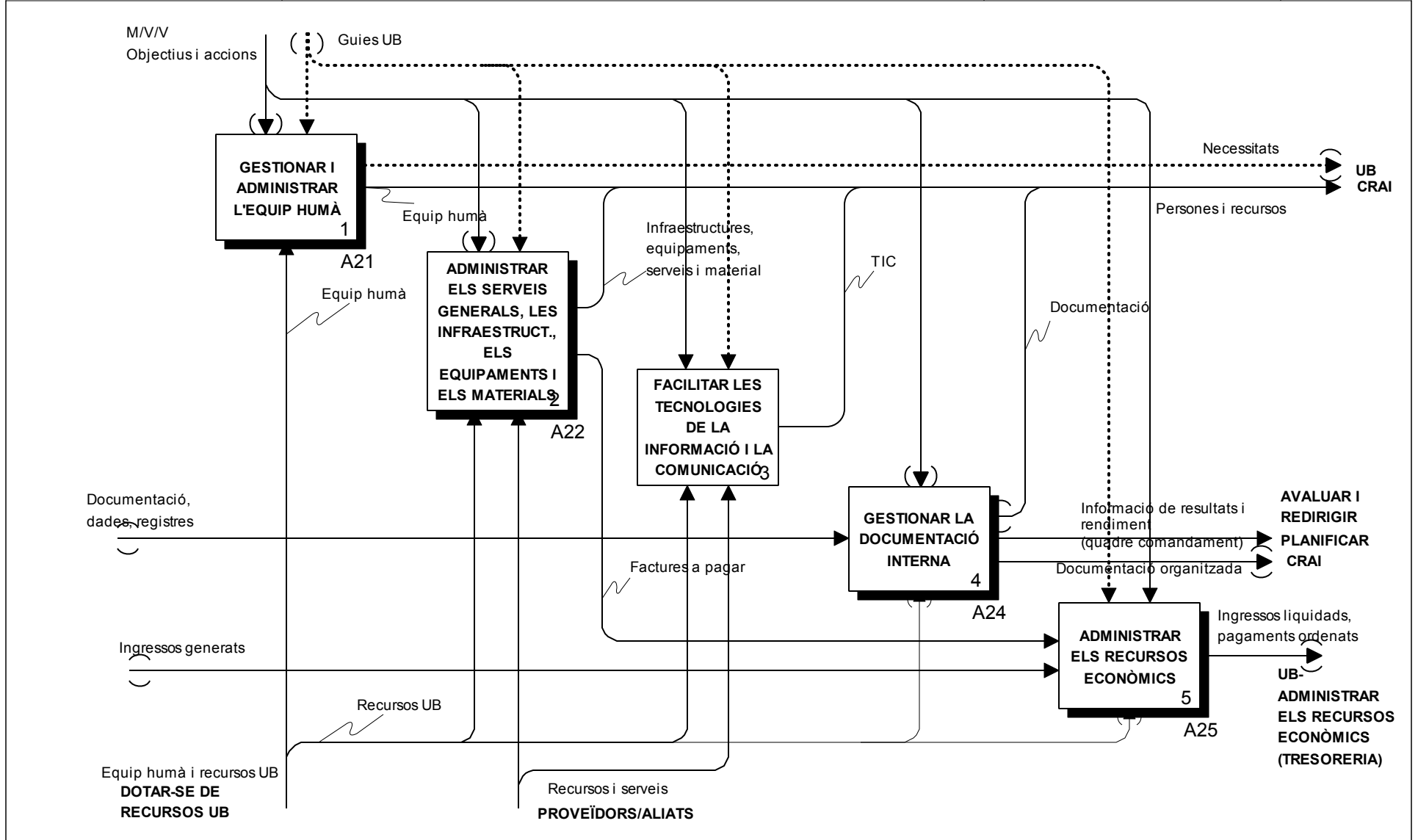

Node: A2	Title: DOTAR-SE DE RECURSOS	Number: 8
-------------	--------------------------------	--------------

Used At:	Author:	Date: 17/01/2012	WORKING	READER	DATE	CONTEXT: <input type="checkbox"/> <input checked="" type="checkbox"/> <input type="checkbox"/> <input type="checkbox"/> A1
	Project: Model Processos CRAI Rev: 17/01/2012		DRAFT			
	Notes: 1 2 3 4 5 6 7 8 9 10		RECOMMENDED			
			PUBLICATION			

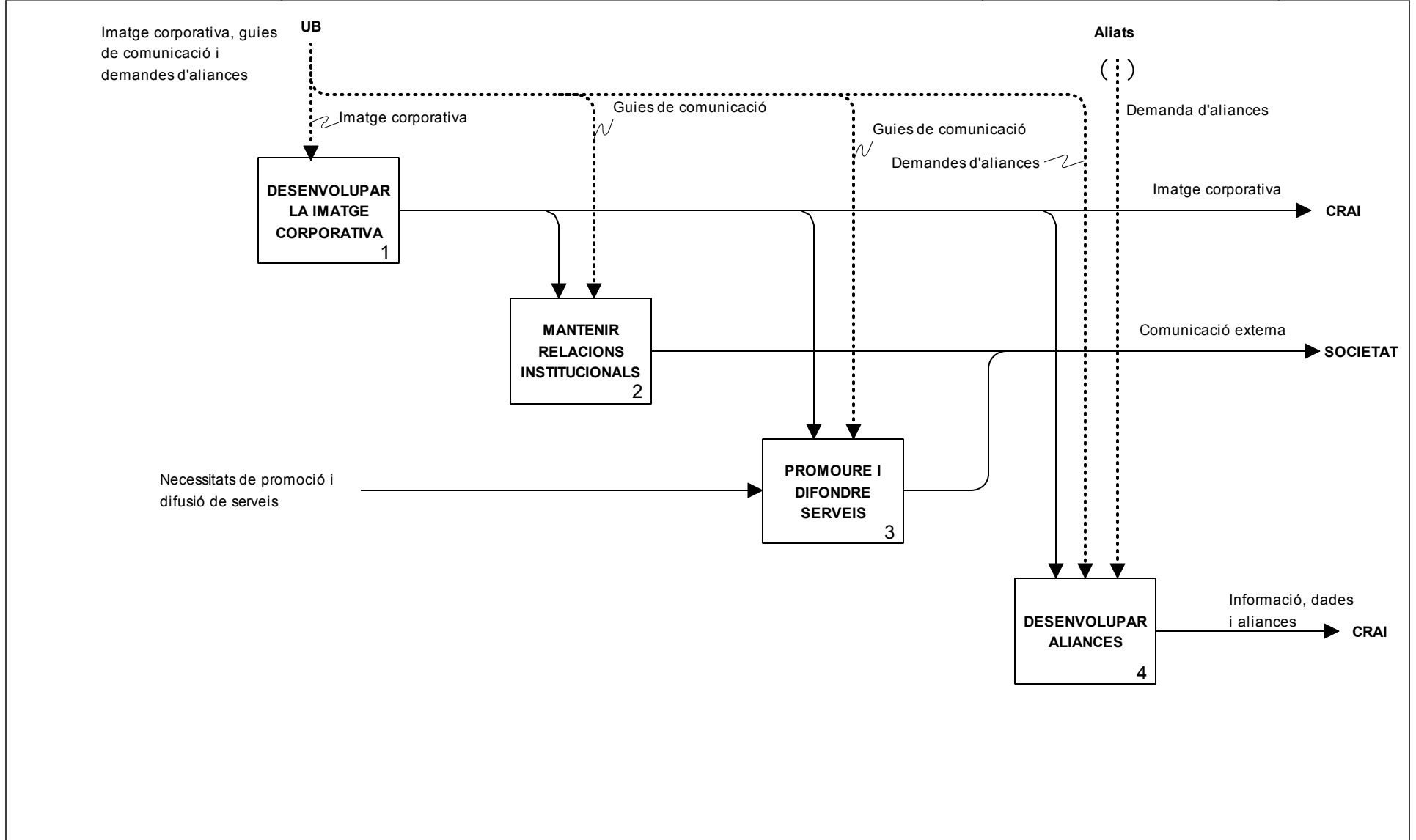

Used At:	Author:	Date: 18/01/2012	WORKING	READER	DATE	CONTEXT: <input checked="" type="checkbox"/> <input type="checkbox"/> <input type="checkbox"/> <input type="checkbox"/> A1
	Project: Model Processos CRAI Rev: 29/06/2017		DRAFT			
	Notes: 1 2 3 4 5 6 7 8 9 10		RECOMMENDED			
			PUBLICATION			

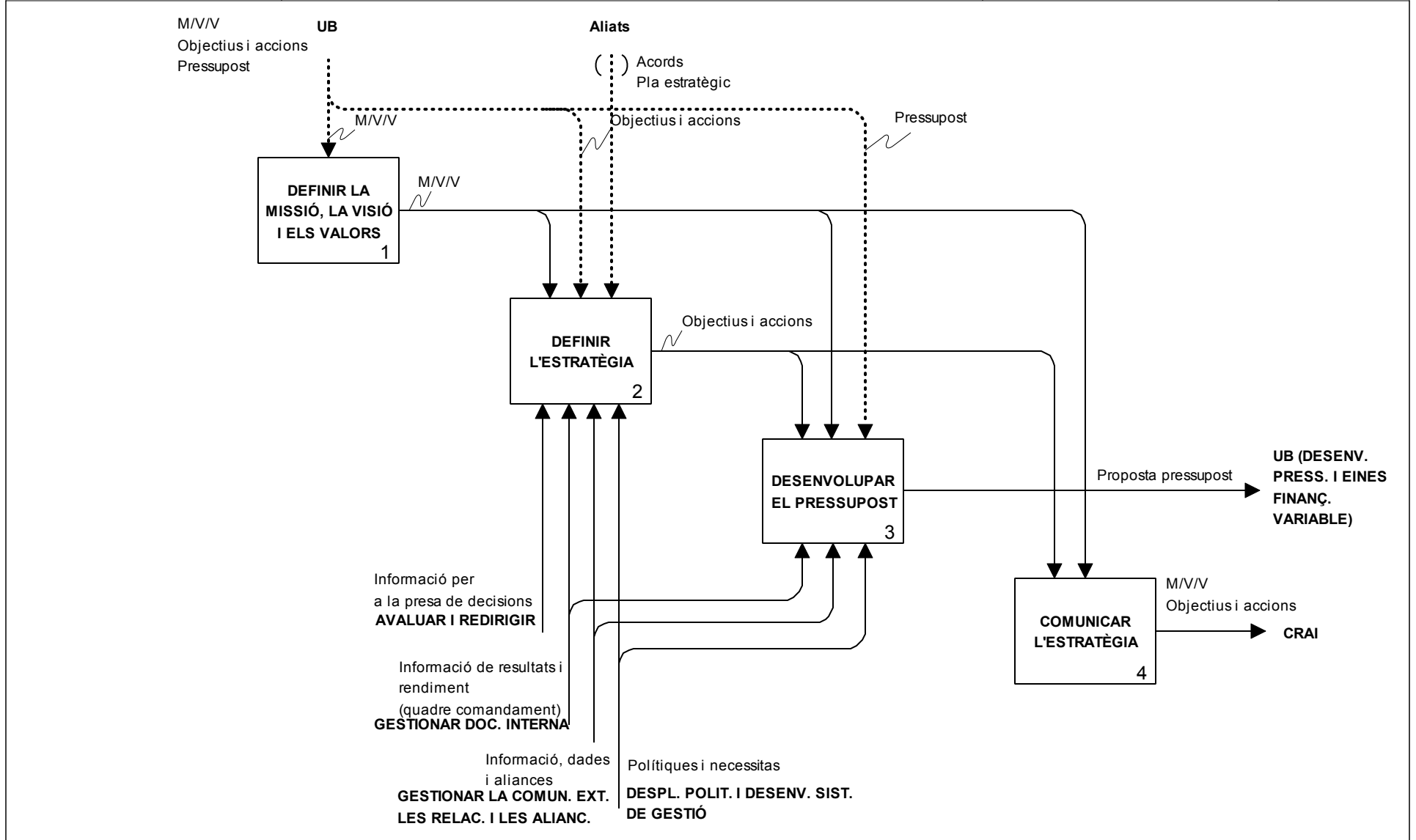

Node: A11	Title: DESENVOLUPAR I COMUNICAR L'ESTRATÈGIA	Number:	Page: 4
--------------	---	---------	---------

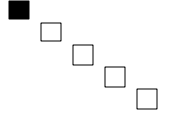

Used At:	Author:	Date: 18/01/2012	WORKING	READER	DATE	CONTEXT:  A2
	Project: Model Processos CRAI Rev: 18/01/2012		DRAFT			
	Notes: 1 2 3 4 5 6 7 8 9 10		RECOMMENDED			
			PUBLICATION			

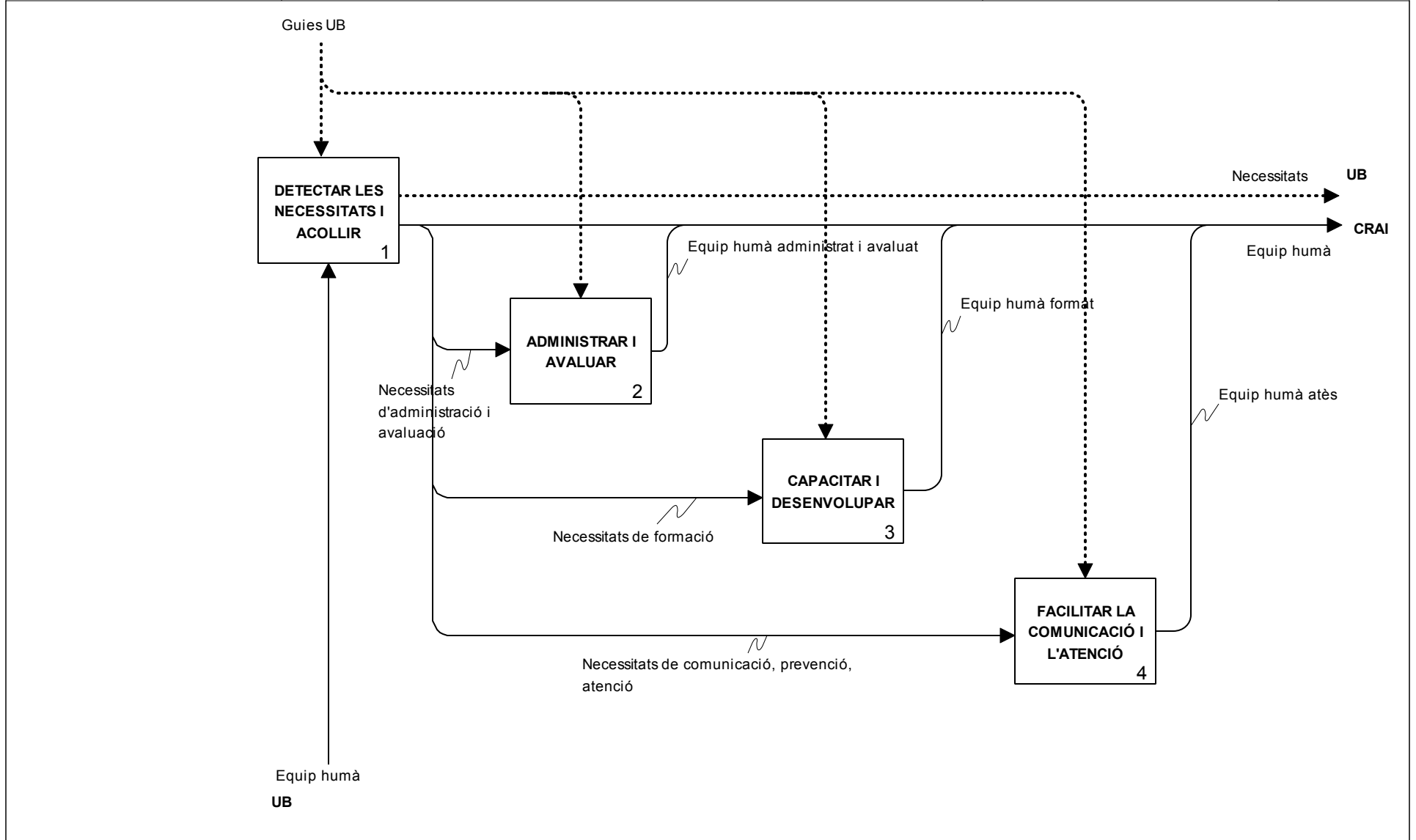

Used At:	Author:	Date: 19/01/2012	WORKING	READER	DATE	CONTEXT: <input type="checkbox"/> <input checked="" type="checkbox"/> <input type="checkbox"/> <input type="checkbox"/> <input type="checkbox"/> A2
	Project: Model Processos CRAI Rev: 19/01/2012		DRAFT			
	Notes: 1 2 3 4 5 6 7 8 9 10		RECOMMENDED			
			PUBLICATION			

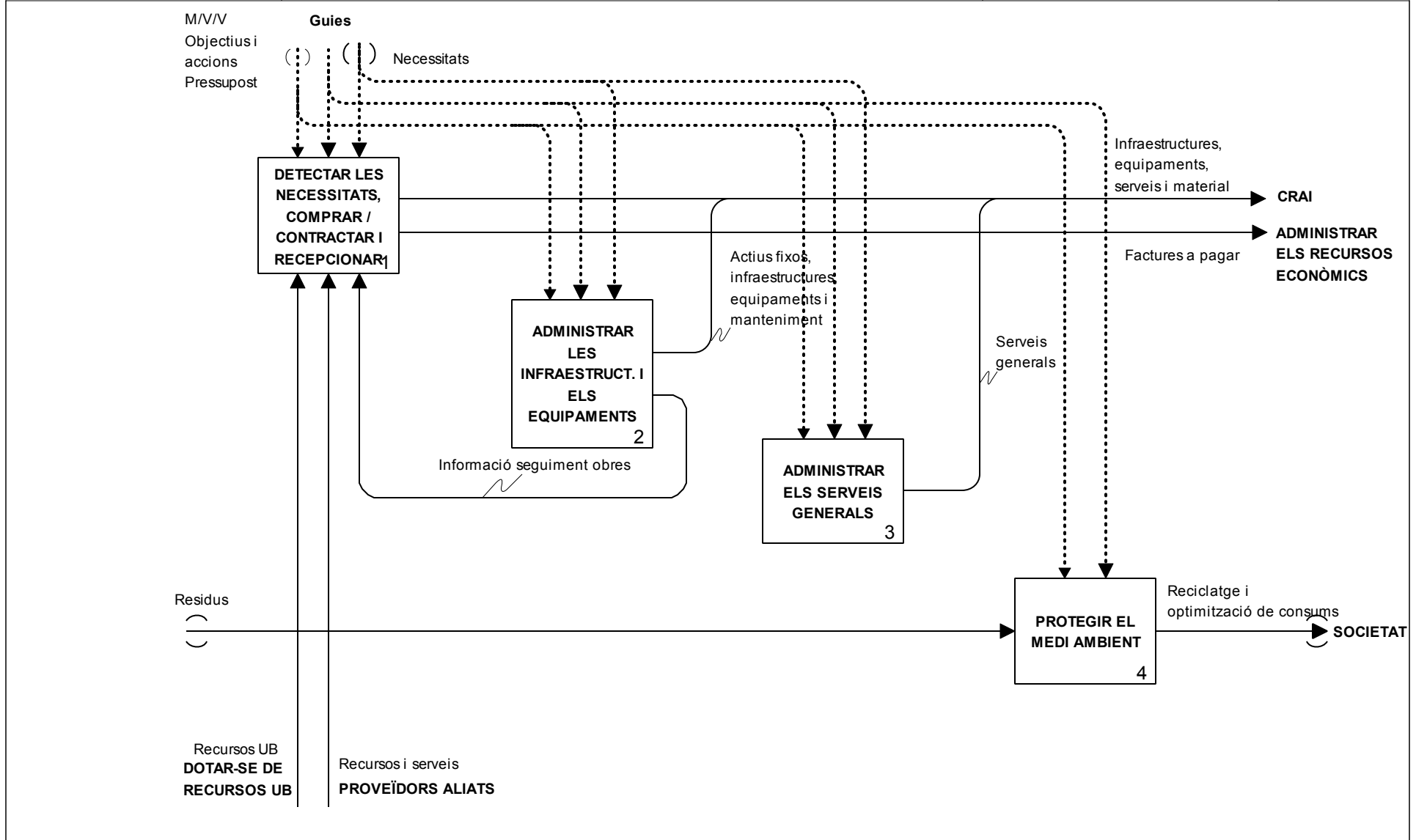

Node: A22	Title: ADMINISTRAR ELS SERVEIS GENERALS, LES INFRAESTRUCT., ELS EQUIPAMENTS I ELS MATERIALS	Number:	Page: 10
--------------	--	---------	----------

Used At:	Author:	Date: 19/01/2012	WORKING	READER	DATE	CONTEXT: <input type="checkbox"/> <input type="checkbox"/> <input type="checkbox"/> <input type="checkbox"/> <input checked="" type="checkbox"/> A2
	Project: Model Processos CRAI Rev: 19/01/2012		DRAFT			
	Notes: 1 2 3 4 5 6 7 8 9 10		RECOMMENDED			
			PUBLICATION			

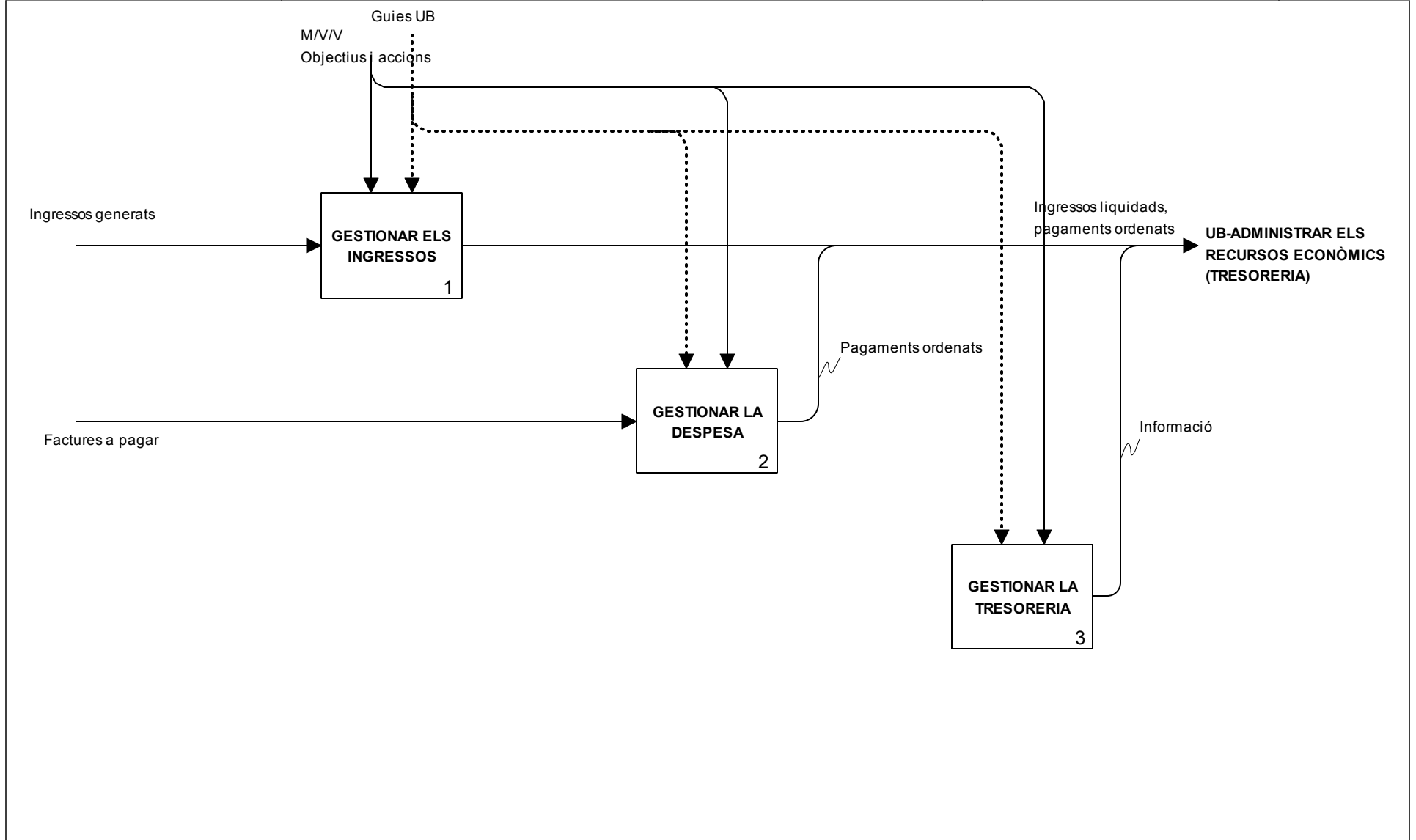

Used At:	Author:	Date: 11/05/2016	WORKING	READER	DATE	CONTEXT: <input type="checkbox"/> <input type="checkbox"/> <input checked="" type="checkbox"/> A3
	Project: Model Processos CRAI Rev: 11/05/2016		DRAFT			
	Notes: 1 2 3 4 5 6 7 8 9 10		RECOMMENDED			
			PUBLICATION			

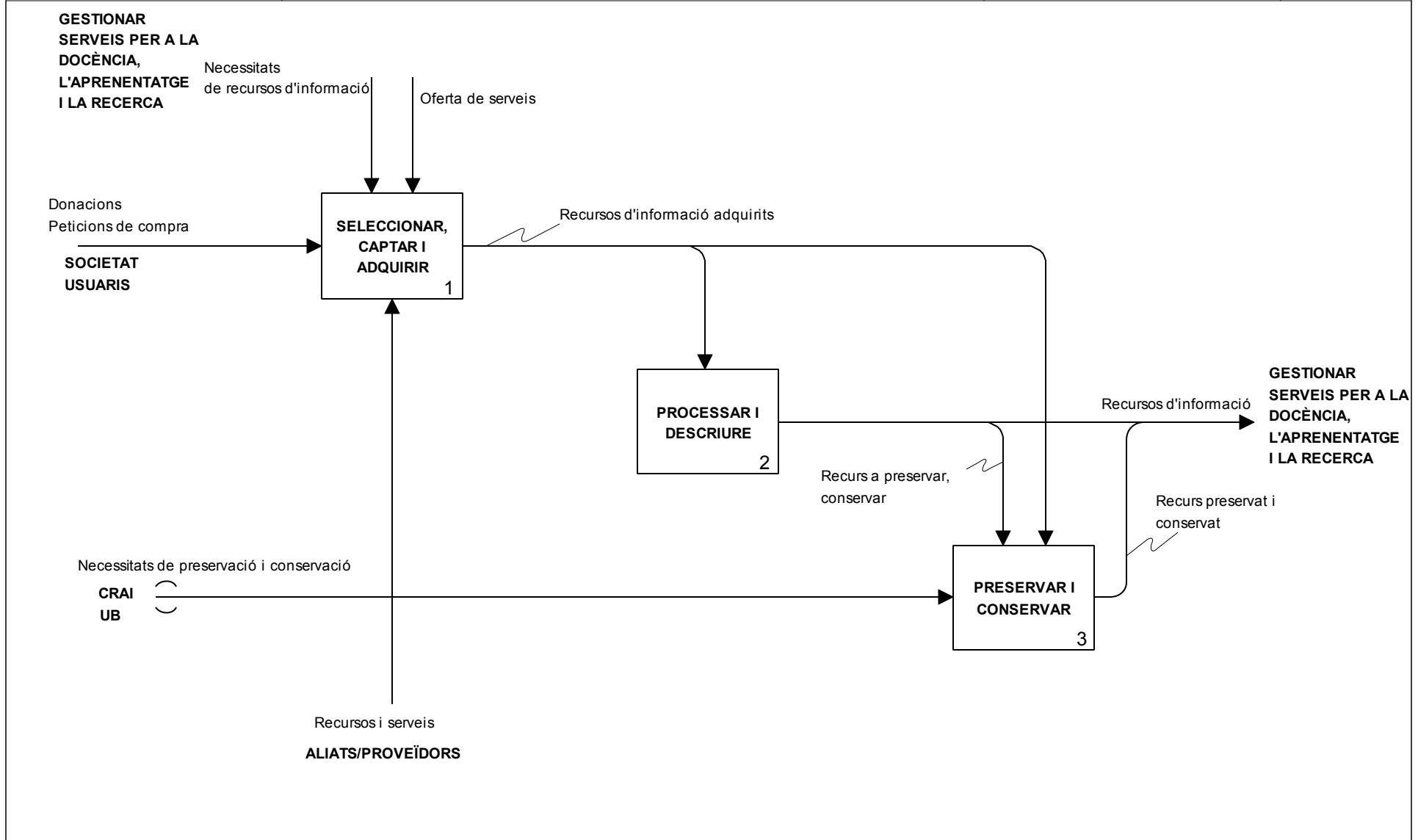

Used At:	Author:	Date: 20/06/2016	WORKING	READER	DATE	CONTEXT: <input type="checkbox"/> <input type="checkbox"/> <input checked="" type="checkbox"/> <input type="checkbox"/> A1
	Project: Model Processos CRAI Rev: 20/06/2016		DRAFT			
	Notes: 1 2 3 4 5 6 7 8 9 10		RECOMMENDED			
			PUBLICATION			

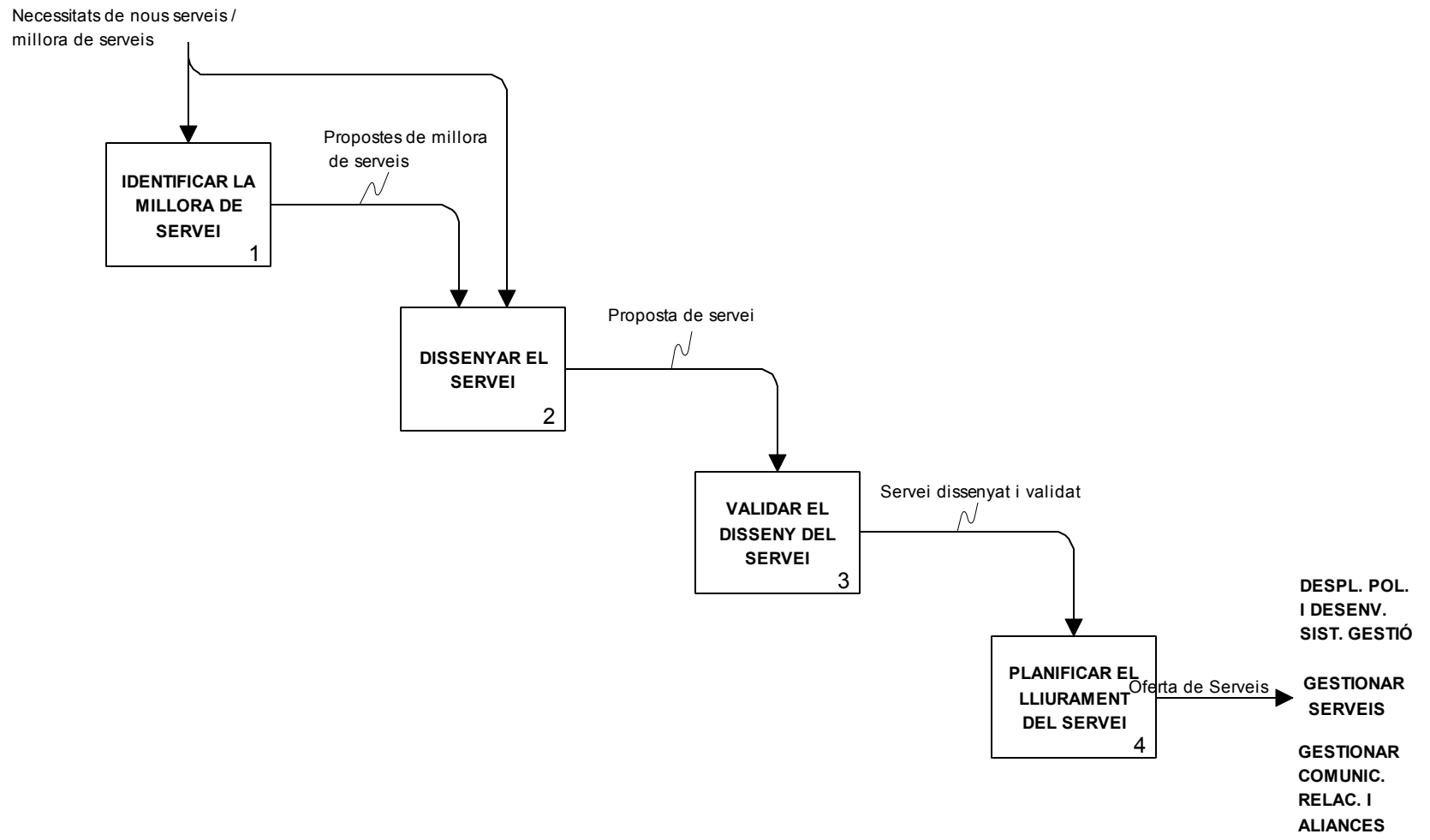

Used At:	Author:	Date: 07/04/2017	WORKING	READER	DATE	CONTEXT:
	Project: Model Processos CRAI Rev: 07/04/2017		DRAFT			<input type="checkbox"/>
	Notes: 1 2 3 4 5 6 7 8 9 10		RECOMMENDED			<input type="checkbox"/>
			PUBLICATION			<input type="checkbox"/>
						<input checked="" type="checkbox"/>
						A1

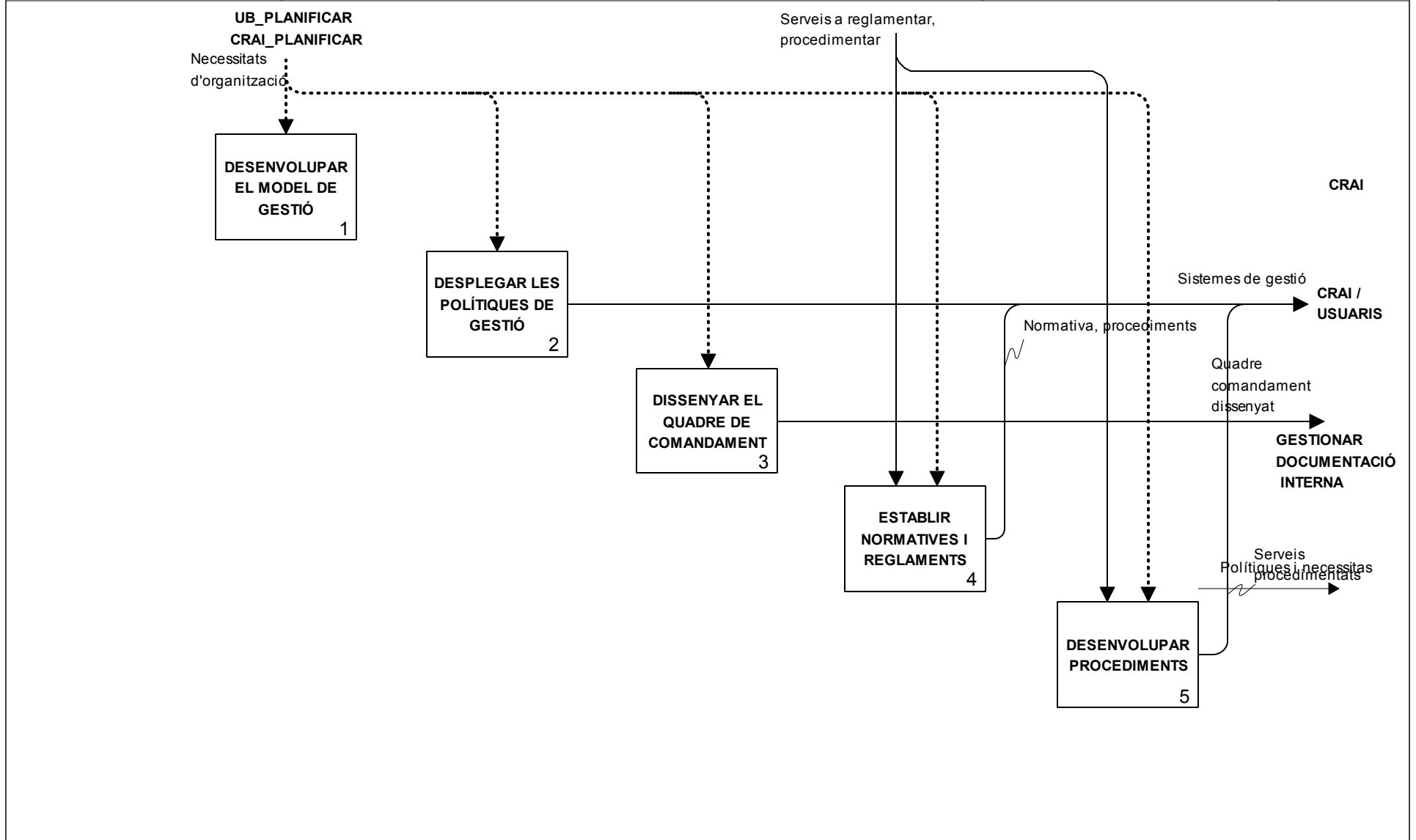

Used At:	Author:	Date: 07/04/2017	WORKING	READER	DATE	CONTEXT: <input type="checkbox"/> <input type="checkbox"/> <input type="checkbox"/> <input checked="" type="checkbox"/> <input type="checkbox"/> A2
	Project: Model Processos CRAI Rev: 07/04/2017		DRAFT			
	Notes: 1 2 3 4 5 6 7 8 9 10		RECOMMENDED			
			PUBLICATION			

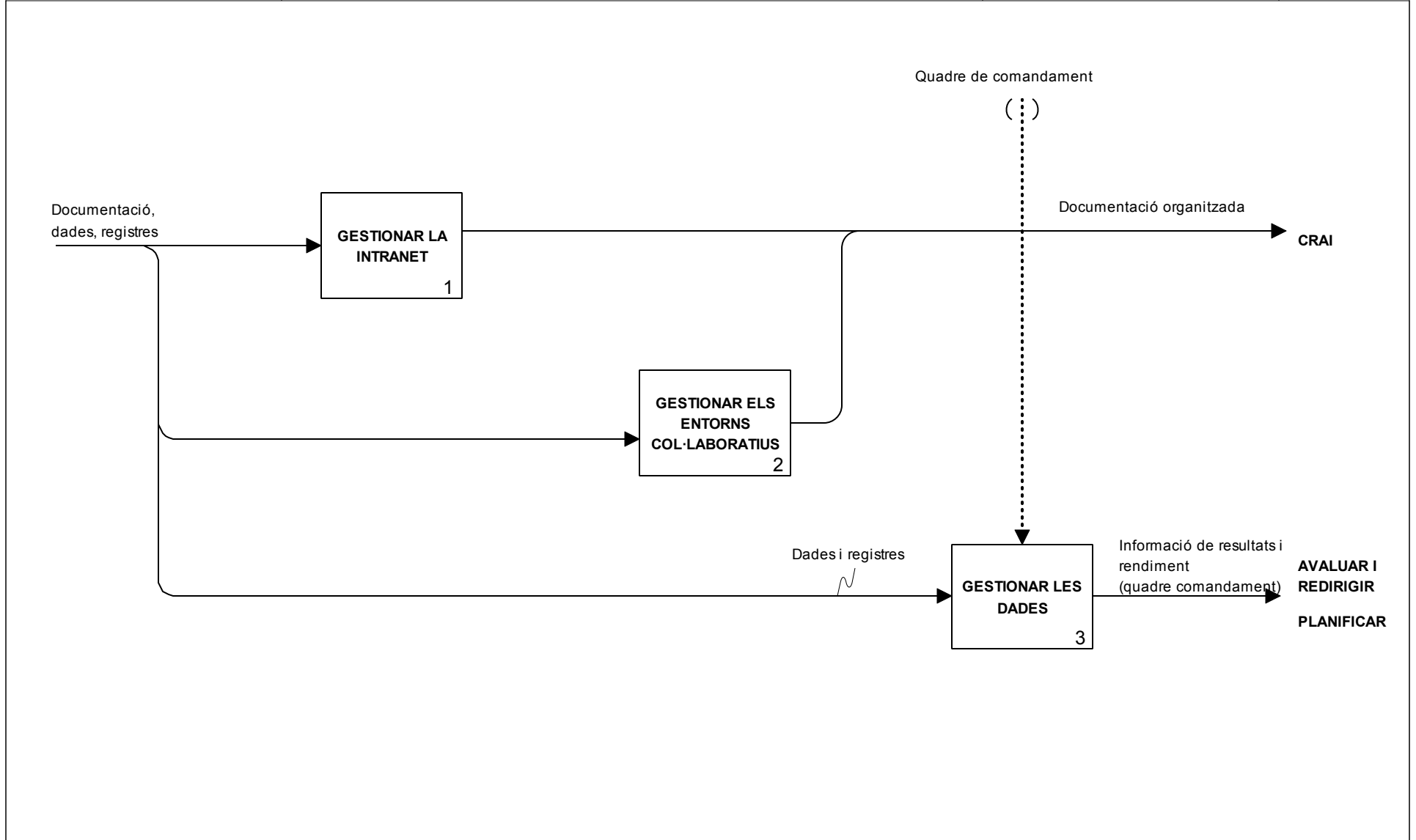

Used At:	Author:	Date: 07/04/2017	WORKING	READER	DATE	CONTEXT: <input type="checkbox"/> <input type="checkbox"/> <input type="checkbox"/> <input checked="" type="checkbox"/> A0
	Project: Model Processos CRAI Rev: 07/04/2017		DRAFT			
	Notes: 1 2 3 4 5 6 7 8 9 10		RECOMMENDED			
			PUBLICATION			

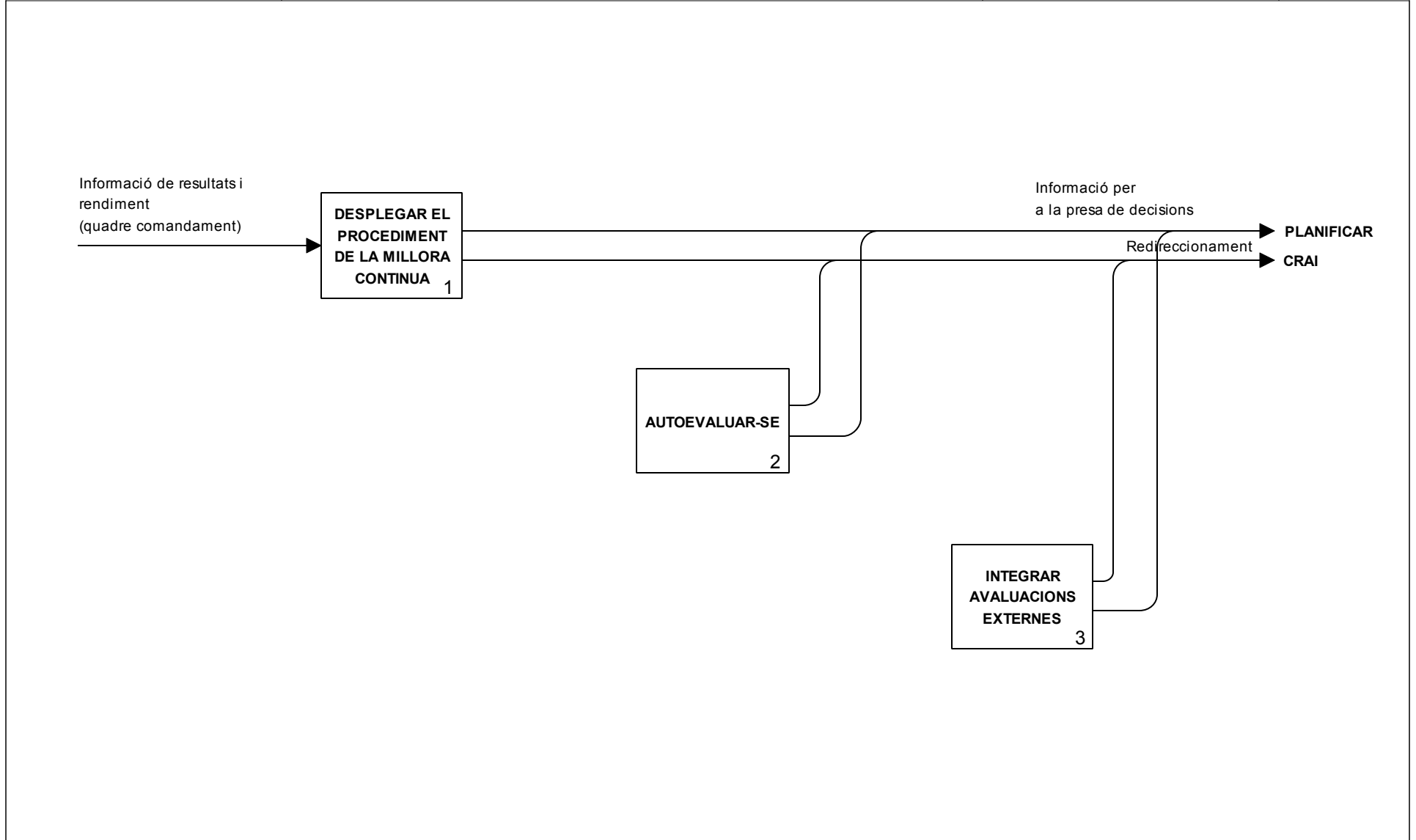

Node: A4	Title: AVALUAR I REDIRIGIR	Number:	Page: 16
-------------	-------------------------------	---------	----------